

# Illustration for led panel light installation

----- Recessed

## Material composition

x4 pcs

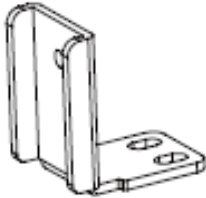

L shape Bracket

x4 pcs



Spring Hanger

x8 pcs



M3\*8.5 screw

x4pcs



M3\*6.5 screw

## Installation

- ① Remove the original screws of this positions



- ② Fix the L shaper bracket with M3\*8.5 self-tapping screws



- ③ Connect the L shape Bracket and Spring hanger by M3\*6.5 screw



- ④ Stretch the four spring hangers and insert onto the backside of roof



- ⑤ Completed

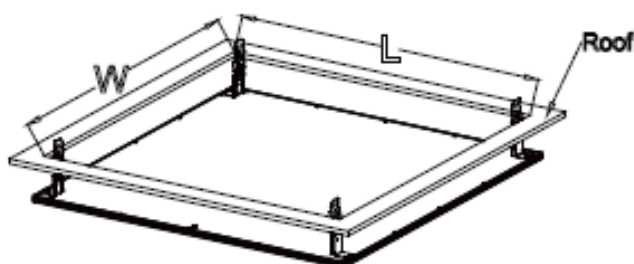

size of panel (mm)	L*W(mm) Mounting Dimensions
595*595	567*567
620*620	592*592
295*295	267*267
295*595	267*567

# Illustration for led panel light installation

## ----- Ceiling mounted

### Material composition

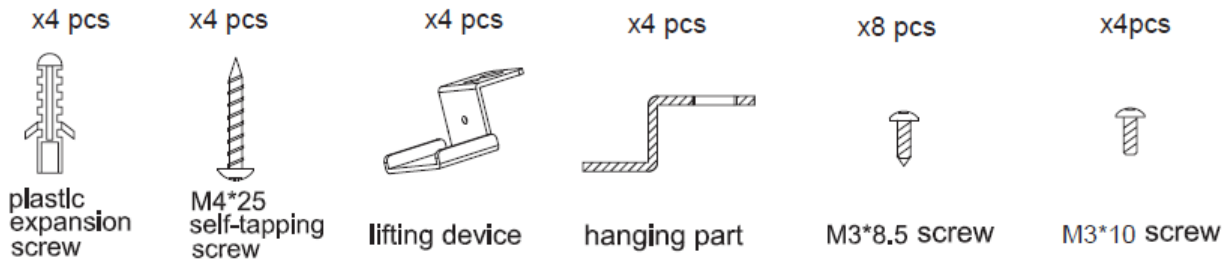

### Installation

1 Remove the screws of this positions

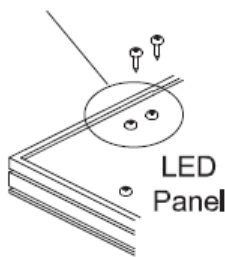

2 fix the hanging parts with M3\*8.5 screws

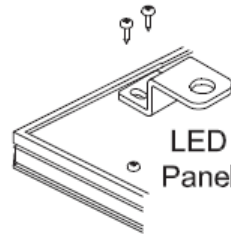

3

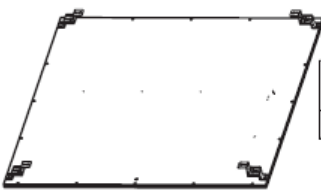

size of panel (mm)	L*W(mm) Mounting Dimensions
MSTC-05411910	510*499

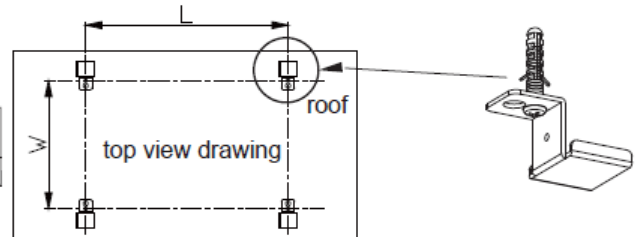

4

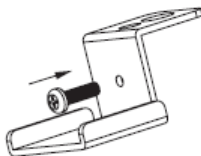

Nalling M3 x10 screws into lifting devices in the direction as the arrow shown. Attention: The screws should not be nalled to the bottom

To fix these four lifting devices on the roof with screws according to the size shown in the illustration



Putting the panel on the lifting devices in the direction as illustration showed (pay attention to the combination between the direction of panel and lifting devices)

5

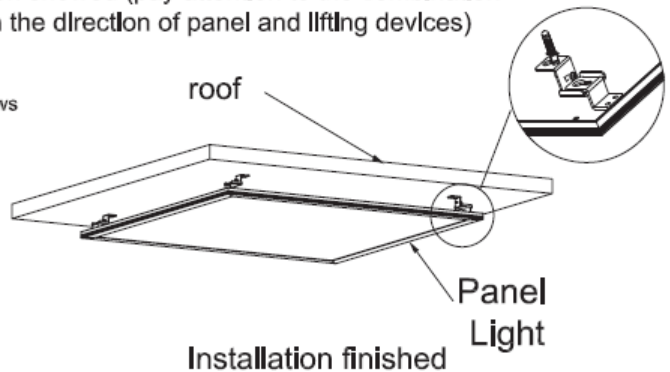
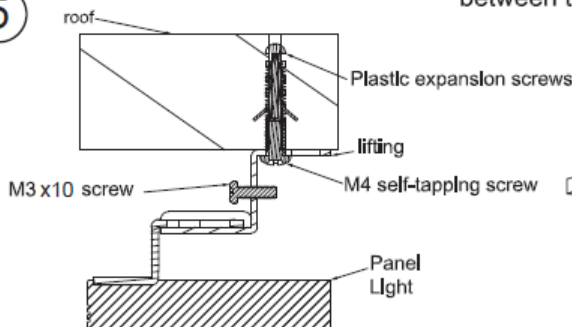

## Illustration for LED Panel Light Installation ----Ceiling Frame

### 1.Components

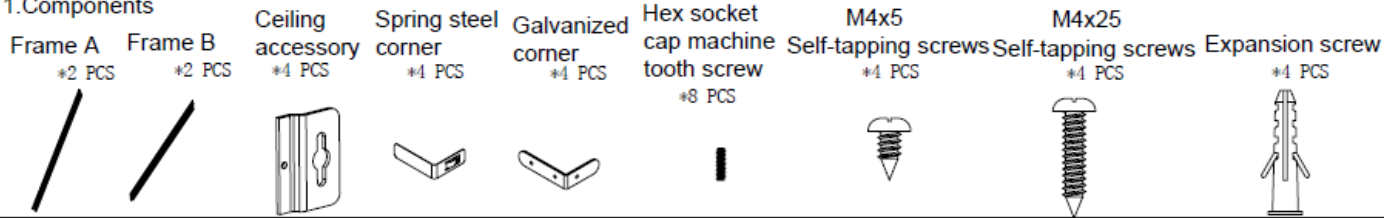

### 2.Assemble the frames according to the following illustration

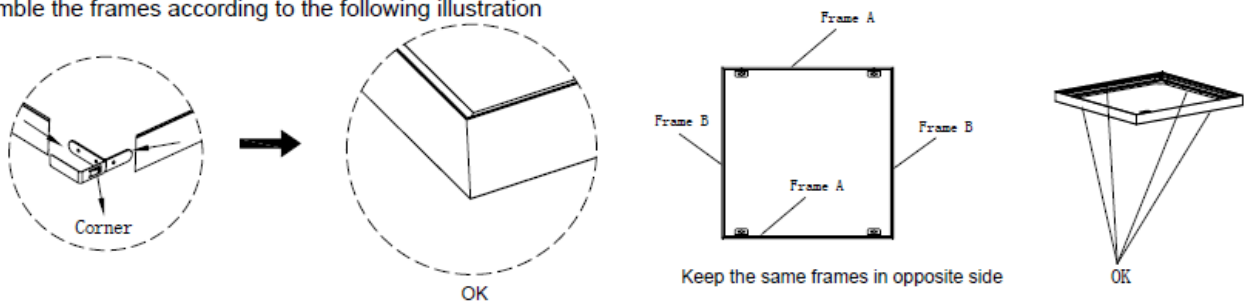

### 3.Mark position details as below

Item No.	L*W(mm)
ACF-P0612-HM/S	1065*554
ACF-P0312-HM/S	1065*254
ACF-P6262-HM/S	490*579
ACF-P0606-HM/S	465*554
ACF-P0306-HM/S	465*254
ACF-P0303-HM/S	165*254

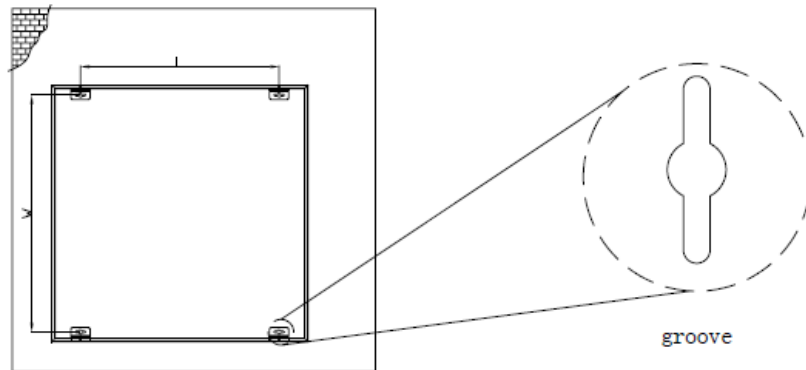

### 4.Installation

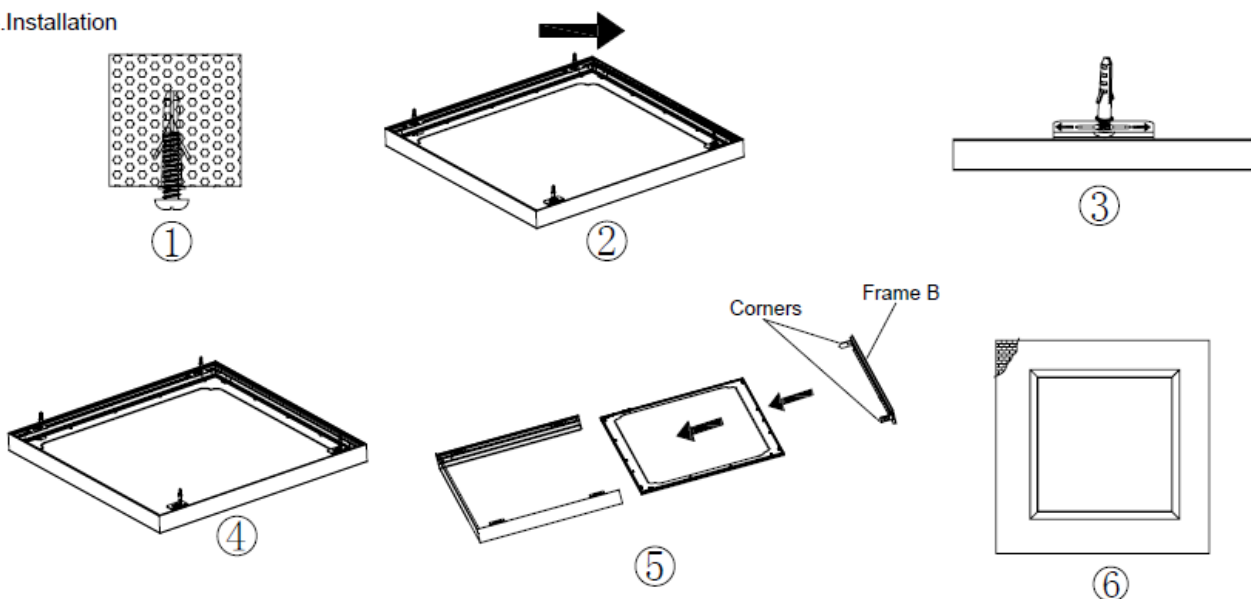













- ① Drill 4 holes at marking position with expansion screws and self-tapping screws(not screw too tight).
- ② Install the assembled frame on the roof.
- ③ Move and fix the ceiling frame (left to right, or right to left) through groove.
- ④ Tighten M4x25 self-tapping screws.
- ⑤ Open the frame B on one side, insert the panel into the frame, then seal the frame.
- ⑥ Installation finished.

# Illustration for led panel light installation-----

## Suspension (ceiling type)

### Material composition

											
plastic expansion screw	M4*25 self-tapping screw	fixing part A	fixing part B	fixing part C	fixing part D	steel rope	regulator	nut	washer	hanging part	M3*8.5 screw
Product Type											
MSTC-05411930	4 PCS	4 PCS	4 PCS	4 PCS	4 PCS	4 PCS	4 PCS	4 PCS	4 PCS	4 PCS	8 PCS

### Installation

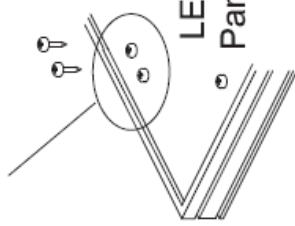
- 

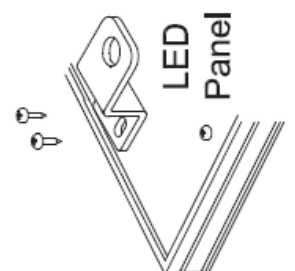
Remove the screws of these positions
- 

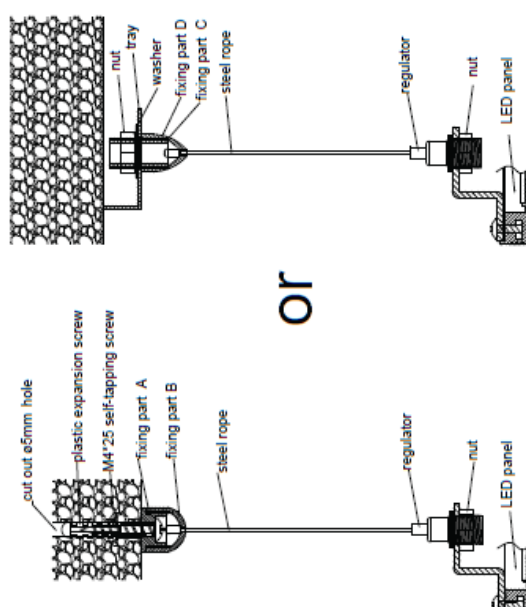
Fix the hanging parts with M3\*8.5 screws
- 

Install as below diagram

or

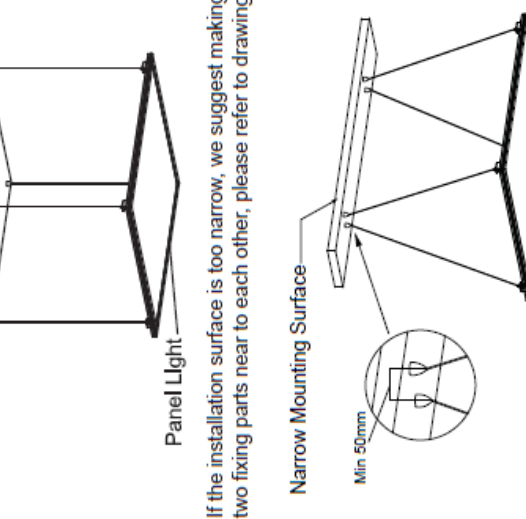
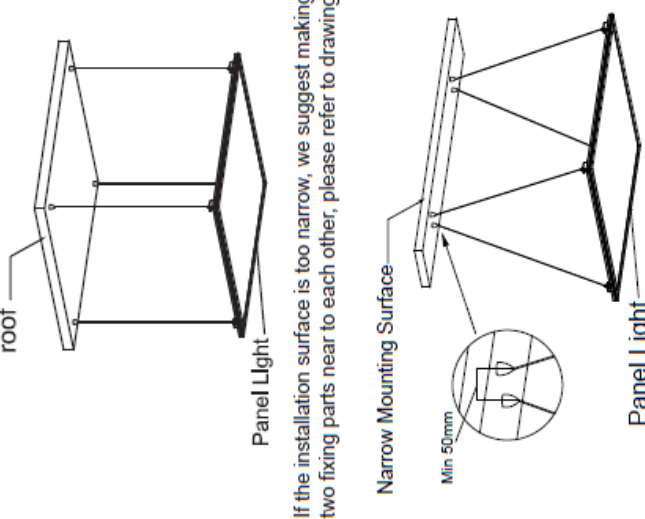
- 

Adjust the regulator to the suitable height

If the installation surface is too narrow, we suggest making the two fixing parts near to each other, please refer to drawing below.